

CX/Z

CAPTIVE COMPONENT GLAND™

for Braided and Steel Tape Cable



Features and Benefits

- For indoor and outdoor use.
- Two piece handling, no loose parts.
- Freely rotating captive cone and inspectible cone ring, providing an armour clamp and earth bond without twisting the armouring.
- Patented disconnect armoured clamp system for ease of inspection.
- Provides a seal on the outer sheath of the cable sealing to IP65/66.
- Precision manufactured from high quality brass (nickel plated) available in stainless steel 316/316L on request.
- Complete with thread sealing gasket and heavy duty locknut.



Technical Data

Type:	CX/Z
Gland Material:	Brass (Nickel Plated) BS 2874, EN 12164, Stainless Steel 316/316L
Seal Material:	Thermoset Elastomer
Cable Type:	Braid, Steel Tape Armour
Armour Clamping:	Rotating Captive Cone and Inspectible Cone Ring
Sealing Area:	Outer Sheath
Optional Accessories:	Adaptor, Reducer, Earth Tag, Locknut, Serrated Washer and Shroud

Standards and Certifications

Mechanical Properties:	Impact Category 8 Anchorage Type C	
Electrical Properties:	Category A	
Operating Temperature:	-20°C to +125°C (continuous)	
Conformance:	Standard:	Certificate:
Design Standards	BS 6121:Part 1 IEC/BS EN 62444 SANS 62444 SANS 1213	CML 14CA364 CML 14CA364 MASC 11-303 MASC 18-2047, SANS 2109/4596 MASC 11-263
IP66 - Parallel	IEC 60529	
IP65 - Tapered	IEC 60529	
Marine ABS	IEC 60529, IEC 62444	ABS 14-SG1246753-2-PDA
DNV-GL	IEC 60529, BS 6121, IEC 62444	DNV-GL TAE000000Z
London Underground Approval	BS EN 62444	LU 3043

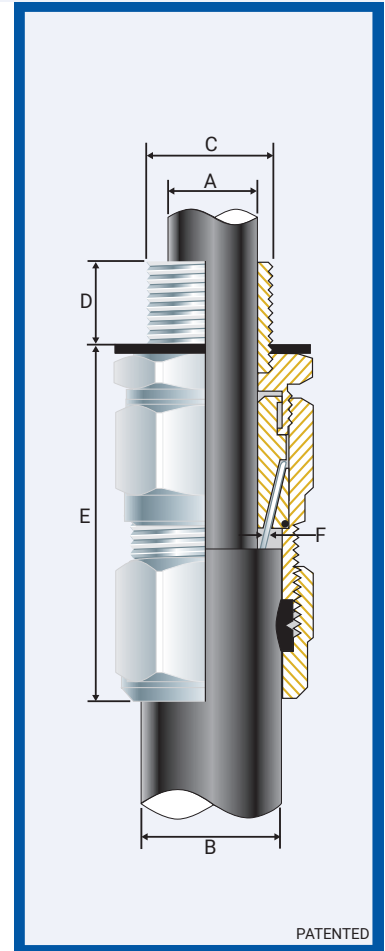

Installation Standards

- AS/NZS 3000
- BS 6121-5
- BS 7671
- BS 7430
- IEC 60364-5-54
- SANS 0142

Product Code	Gland Size Reference	Metric Entry Thread		NPT Entry Thread		Cable Detail			Maximum Length 'E'	Braid/STA Thickness		Hexagonal Detail		Installation Torque Value Nm
		'C'	Min 'D'	'C'	Min 'D'	Max 'A'	Min 'B'	Max 'B'		Min 'F'	Max 'F'	Max 'Flats'	Max 'Crns'	
051300-16	00-16ss	M16x1.5	10	-	-	8.0	8.0	13.5	55.0	0.20	0.85	24.0	27.0	35.0
051300	00-20ss	M20x1.5	10	1/2/3/4	15	8.0	8.0	13.5	55.0	0.20	0.85	24.0	27.0	35.0
0513-0	0-20s	M20x1.5	10	1/2/3/4	15	12.0	11.5	16.0	55.0	0.20	0.90	24.0	27.0	35.0
051301	1-20	M20x1.5	10	1/2/3/4	15	15.5	14.5	20.5	55.0	0.20	1.25	27.0	30.0	35.0
051322	2s-25s	M25x1.5	10	3/4/1	15/19	20.0	16.0	24.5	60.0	0.20	1.25	35.0	39.0	50.0
051302	2-25	M25x1.5	10	3/4/1	15/19	20.0	20.5	26.5	60.0	0.20	1.25	35.0	39.0	50.0
051333	3s-32s	M32x1.5	10	1/1 1/4	19	26.5	23.0	30.5	65.0	0.20	1.40	42.0	47.0	70.0
051303	3-32	M32x1.5	10	1/1 1/4	19	26.5	26.5	33.5	65.0	0.20	1.40	42.0	47.0	70.0
051344	4s-40s	M40x1.5	15	1 1/4/1 1/2	19/21	34.5	30.0	39.5	65.0	0.30	1.40	52.0	59.0	90.0
051304	4-40	M40x1.5	15	1 1/4/1 1/2	19/21	34.5	33.0	42.5	65.0	0.30	1.40	52.0	59.0	90.0
051355	5s-50s	M50x1.5	15	1 1/2/2	21	44.5	34.0	47.5	75.0	0.40	1.40	65.0	73.0	100.0
051305	5-50	M50x1.5	15	1 1/2/2	21	44.5	42.5	52.5	75.0	0.40	1.40	65.0	73.0	100.0
051366	6s-63s	M63x1.5	15	2/2 1/2	21/30	57.0	45.5	60.5	85.0	0.40	1.50	80.0	90.0	120.0
051306	6-63	M63x1.5	15	2/2 1/2	21/30	57.0	52.5	65.5	85.0	0.40	1.50	80.0	90.0	120.0
051377	7s-75s	M75x1.5	15	2 1/2/3	30/ 32	68.0	57.0	72.5	105.0	0.40	1.50	96.0	108.0	120.0
051307	7-75	M75x1.5	15	2 1/2/3	30/32	68.0	65.5	78.0	105.0	0.40	1.50	96.0	108.0	120.0
051388	8s-80s	M80x2.0	20	3	32	74.0	65.0	77.5	125.0	2.50	1.60	96.0	108.0	120.0
051308	8-80	M80x2.0	20	3	32	74.0	78.0	82.0	125.0	2.50	1.60	96.0	108.0	120.0
051399	9s-90s	M90x2.0	20	3/3 1/2	32/33	82.0	73.0	86.5	145.0	3.00	1.60	110.0	124.0	120.0
051309	9-90	M90x2.0	20	3/3 1/2	32/33	82.0	82.0	91.0	145.0	3.00	1.60	110.0	124.0	120.0

All dimensions except NPT are in mm.

CCG reserves the right to make alterations to the technical data, dimensions, designs and products available without notice. The illustrations cannot be considered binding. Please contact CCG for assistance.

CXZ-IN201118E

CX/Z CAPTIVE COMPONENT GLAND™

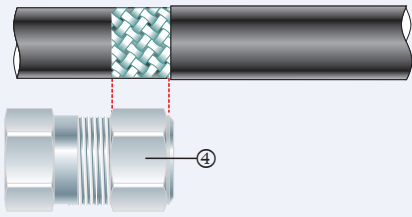

1. Cut back the cable outer sheath to expose the braid to a length not more than the outer nut ④.

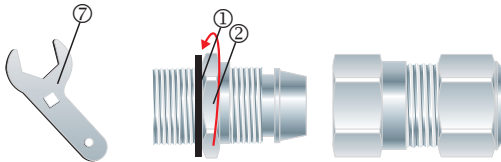

2. To maintain IP66 ensure the gasket ① is in place. Screw the inner ② into apparatus. Tighten the inner ② to the installation torque using a CCG Spanner ⑦.

Alternative installation through an unthreaded entry.

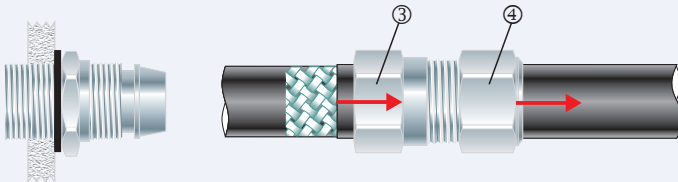
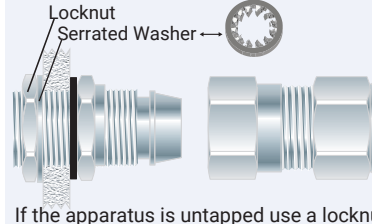

3. Pass the outer nut ④ and the body ③ over the cable.

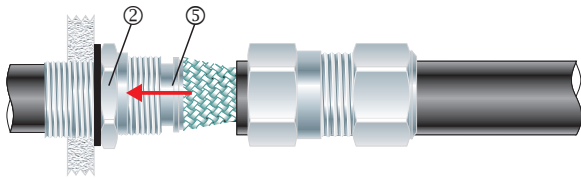

4. Pass cable end through the inner ②. Splay the braid over the cone ⑤.

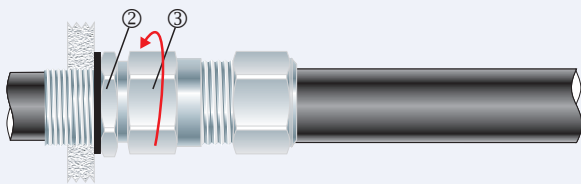

5. Tighten the body ③ onto the inner ② to lock the braid between the cone ⑤ and the cone ring ⑥.

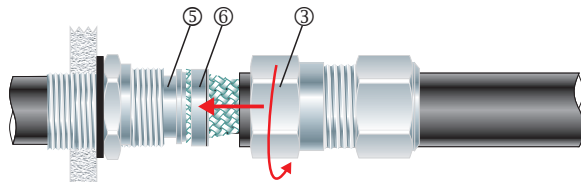

6. Unscrew the body ③. Check that the braid has locked between the cone ⑤ and the cone ring ⑥. (O-Ring on the cone ring ⑥ is sacrificial).

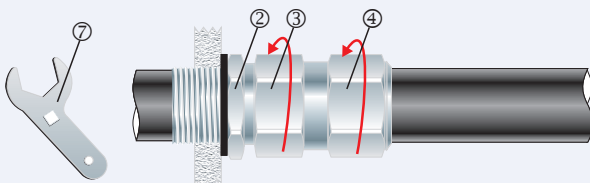

7. Tighten the body ③ into the inner ② and tighten the body ③ to installation torque using a CCG Spanner ⑦. Tighten the outer nut ④ to produce a moisture proof seal by turning until the seal makes contact with the outer sheath of cable and then make one full turn.