



# E1EX-U

Ex db I/ IIC, Ex eb I/IIC, Ex ta IIIC, Ex nR IIC

CAPTIVE COMPONENT GLAND® for Multi Armoured Cable

## Features and Benefits

- For indoor, outdoors, Group I, II, III, Zone 1, 2, 21 and 22 hazardous areas.
- Freely rotating captive cone and inspectible cone ring provides an armour clamp and earth bond for steel wire, aluminium, braid and tape armour.
- Patented disconnect system that allows inspection of armour clamp and inner seal after assembly.
- Factory fitted captive elastomeric seals for Built-in Safety™. Seals on both inner and outer sheaths to IP66/68.
- Precision manufactured from high-quality brass (Marine Grade Electroless Nickel Plated™) available in stainless steel 316/316L on request. Supplied with a thread-sealing gasket (parallel threads only).



## Technical Data

Type:	E1EX-U (Universal)
Gland Material:	Brass (Marine Grade Electroless Nickel Plated™), Stainless Steel 316/316L
Seal Material:	Standard Thermoset Elastomer or Extreme Temperature Seals
Sealing Gasket Material:	HDPE, Nylon 66 or PTFE
Cable Type:	Steel Wire, Aluminium, Braided and Tape Armour
Armour Clamping:	Rotating Captive Cone and Inspectible Cone Ring
Sealing Area:	Inner Sheath and Outer Sheath
Optional Accessories:	Adaptor, Reducer, Earth Tag, Locknut, Serrated Washer and Shroud
Note:	The installer should ensure that the materials are suitable for the installation environment.

## Standards and Certifications

Equipment Protection Levels:	IECEx/INMETRO: Ex db eb I Mb, Ex db eb IIC Gb, Ex nR IIC Gc, Ex ta IIIC Da ATEX/UKEX: Ex db eb I Mb, Ex db eb IIC Gb, Ex nR IIC Gc, Ex ta IIIC Da TR CU: Ex db eb I Mb, Ex db eb IIC Gb, Ex nR IIC Gc, Ex ta IIIC Da CCC: Ex db IIC Gb, Ex eb IIC Gb, Ex ta IIIC Da	
Continuous Operating Temp:	Standard Seals: -60°C to +95°C / 100°C (HDPE/ Nylon Sealing Gasket) Extreme Temp. Seals: -60°C to +160°C (PTFE Sealing Gasket)	
Conformance:	Standard:	Certificate:
IEC/BS EN	IEC/BS EN 62444	CML 14CA364
IECEX	IEC 60079 Part 0, 1, 7, 15, 31	IECEX TSA 22.0011X
ATEX	EN 60079 Part 0, 1, 7, 31	CML 16ATEX1001X
	EN 60079 Part 0, 15	CML 16ATEX4002X
UKEX	BS EN 60079 Part 0, 1, 7, 31	CML 21UKEX1011X
	BS EN 60079 Part 0, 15	CML 21UKEX4006X
INMETRO (Brazil)	ABNT NBR IEC 60079 Part 0, 1, 7, 15, 31	TUV 15.0483X
TR CU (Russia)	ГОСТ 31610-0, 15, ГОСТ IEC 60079-1	EA3C RU C-ZA.HA91.B.00245/21
	ГОСТ P M3K 60079-7, 31	
CCC/CNEx (Chinese)	GB/T3836.1, 2, 3, 31-2021	CNEx 21.3387X, CCC 2021312313000396
KCs (Korea)	Notification of Ministry of Labour No.2013-54	17-AV4B0-0087-90X
SANS	SANS/IEC 60079 Part 0, 1, 7, 15, 31	MASC MS/22-9001X
IP66/68 100m - Parallel	IEC 60529	CML 15Y728
IP65/66 - Tapered	IEC 60529	
IP68 - Tapered and approved grease	IEC 60529	IECEX TSA 22.0011X
Deluge Protection	DTS-01	CML 14CA370-2
Corrosion Protection	ASTM B117-11, BS EN ISO 3231	EXOVA N968667
Marine ABS	IEC 60079 Part 0, 1, 7, 15, 31, IEC 60529	ABS 20-1952706-1-PDA
DNV	IEC 60079 Part 0, 1, 7, IEC 60529	TAE0000010
ClassNK	IEC 60079 Part 0, 1, 7, 15, 31	TA20271M
EMC Compatible	EN 55011, + A1, EN 55022	SGS EMC305079/1

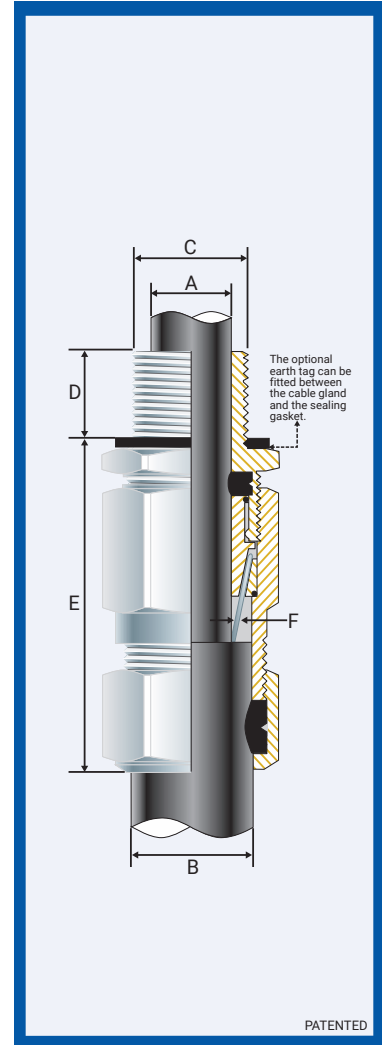

## Conditions for Safe Use - X

- The cable glands shall only be used where the temperature, at the point of entry, is between -60°C to +95°C (standard seals & HDPE sealing gaskets), -60°C to +100°C (standard seal and Nylon sealing gasket) or -60°C to +160°C (extreme temp. seal & PTFE sealing gasket) depending on seal and gasket used.
- Braided cables are only suitable for Group II or III applications with this gland and the user shall ensure adequate clamping of the cable.

Note: According to IEC 60079-14, 10.6.2: An Ex d gland will only maintain Ex d integrity when used with substantially round, compact and filled cable. If not a CCG VORTEX® barrier gland should be used.

Product Code	Gland Size Reference	Metric Entry Thread		NPT Entry Thread		Cable Detail				Max Length 'E'	Armour Dia		Hexagonal Detail		Install. Torque Value Nm
		'C'	Min 'D'	'C'	Min 'D'	Min 'A'	Max 'A'	Min 'B'	Max 'B'		Min 'F'	Max 'F'	Max 'Flats'	Max 'Crns'	
057100-16	00-16ss	M16x1.5	15	-	-	3.0	8.5	5.0	10.5	60.0	0.20	0.90	25/27	28/30	21.0
057100S	00s-20ss	M20x1.5	15	1/2 3/4	15	3.0	8.5	5.0	10.5	60.0	0.20	0.90	25/27	28/30	21.0
057100	00-20ss	M20x1.5	15	1/2 3/4	15	3.0	8.5	8.0	13.5	60.0	0.20	0.90	25/27	28/30	21.0
0571-0S	0s-20s	M20x1.5	15	1/2 3/4	15	7.0	12.0	8.0	13.5	60.0	0.20	1.25	25/27	28/30	21.0
0571-0	0-20s	M20x1.5	15	1/2 3/4	15	7.0	12.0	11.5	16.0	60.0	0.20	1.25	25/27	28/30	21.0
057101	1-20	M20x1.5	15	1/2 3/4	15	9.0	15.0	12.5	20.5	73.0	0.20	1.25	30	34	21.0
057122	2s-25s	M25x1.5	15	3/4 1	15/19	11.0	17.5	16.0	24.5	82.4	0.20	1.60	38	43	30.0
057102	2-25	M25x1.5	15	3/4 1	15/19	14.0	20.0	18.0	27.0	82.0	0.20	1.60	38	43	30.0
057133	3s-32s	M32x1.5	15	1 1/4	19	15.0	22.0	20.0	30.5	91.0	0.20	2.00	45	51	42.0
057103	3-32	M32x1.5	15	1 1/4	19	19.0	26.5	23.0	33.5	91.0	0.20	2.00	45	51	42.0
057144	4s-40s	M40x1.5	15	1 3/4 1 1/2	19/21	22.0	31.5	26.5	39.5	105.0	0.30	2.00	55	62	52.0
057104	4-40	M40x1.5	15	1 3/4 1 1/2	19/21	26.0	34.0	28.0	40.0	105.0	0.30	2.00	55	62	52.0
057155	5s-50s	M50x1.5	15	1 1/2 2	21	29.0	38.0	35.2	46.7	123.0	0.40	2.50	65	73	57.0
057105	5-50	M50x1.5	15	1 1/2 2	21	34.0	44.5	44.4	53.0	123.0	0.40	2.50	65	73	57.0
057166	6s-63s	M63x1.5	15	2 1/2 2 1/2	21/30	38.0	50.0	45.5	59.4	147.0	0.40	2.50	85	96	66.0
057106	6-63	M63x1.5	15	2 1/2 2 1/2	21/30	44.0	56.5	54.6	65.9	147.0	0.40	2.50	85	96	66.0
057177	7s-75s	M75x1.5	15	2 1/2 3	30/32	50.0	62.0	59.0	72.5	149.0	0.40	3.15	96	108	72.0
057107	7-75	M75x1.5	15	2 1/2 3	30/32	56.0	67.5	65.0	78.0	149.0	0.40	3.15	96	108	72.0
057108	8-80	M80x2.0	20	3	32	59.0	69.0	65.0	77.5	195.0	0.40	3.15	96	108	80.0
057199	9s-90s	M90x2.0	20	3 3/3 1/2	32/33	66.0	75.0	73.0	86.5	204.0	0.40	3.50	111	125	89.0
057109	9-90	M90x2.0	20	3 3/3 1/2	32/33	74.0	81.5	82.0	91.0	204.0	0.40	3.50	111	125	89.0
057110	10-100	M100x2.0	20	3 1/2 4	33/34	81.0	91.0	90.0	100.0	209.0	0.40	3.50	125	141	98.0

All dimensions except NPT are in mm. Intermediate thread sizes are available on request. NPT threads should be tightened 'wrench tight'.

CCG reserves the right to make alterations to the technical data, dimensions, designs and products available without notice. The illustrations cannot be considered binding. Please contact CCG for assistance.

E1EXU-HMG010424E

# E1EX-U GLAND

### ENCLOSURES AND EQUIPMENT TO WHICH CABLE GLANDS ARE FITTED:-

- Must be made from materials which are compatible with the cable gland materials.
- Have a sealing area around the cable gland entry point with a surface roughness <math>< Ra 6.3 \mu m</math>.
- Have entries that are perpendicular to the enclosure face in the area where the cable gland will seal to within  $2.5^\circ$ .
- Are sealed using the supplied sealing gasket (parallel threads) or by fully tightening into a threaded entry (tapered threads). Note that for tapered threads the IP rating can be improved to IP68 with the use of a suitable thread sealant.

### MUST HAVE THREADED ENTRIES

- The same thread size as the cable gland. (Thread adapters should be used to correct

any mismatch).

- With a thread tolerance of metric class '6H' or equivalent.
- Where the thread length is a minimum of 10mm for Ex d applications or 3mm for all other applications

### OR CLEARANCE HOLES (not Ex d)

- Where the hole size is the thread nominal size with a tolerance of +0.1 to +0.7mm. (e.g. the clearance hole for an M20 thread will have a diameter between 20.1mm and 20.7mm).
- Through material that is between 1mm and 12mm thick. (Thicker materials can be accommodated using glands with extended entry threads.)

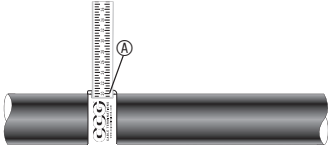

1. For accurate sizing, use a CCG Dimension Tape (A) on the outer cable sheath.

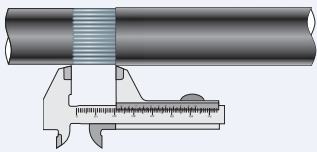

Gland Size	Armour Length	Gland Size	Armour Length	Gland Size	Armour Length	Gland Size	Armour Length
00-16ss	20.0	2-25	25.0	5s-50s	35.0	7-75	50.0
00-20ss	20.0	3s-32s	30.0	5-50	35.0	8-80	50.0
0-20s	20.0	3-32	30.0	6s-63s	45.0	9s-90s	50.0
1-20	25.0	4s-40s	30.0	6-63	45.0	9-90	50.0
2s-25s	25.0	4-40	30.0	7s-75s	50.0	10-100	60.0

2. Cut back the cable outer sheath to expose the armour to a length as per the table above.

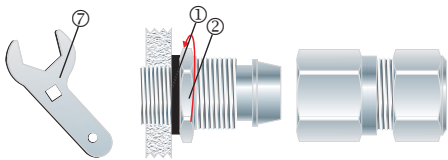

3. To maintain IP66/68 ensure the gasket (1) is in place. Tighten the inner (2) into the apparatus. Tighten the inner (2) to the torque using a CCG Spanner (7).

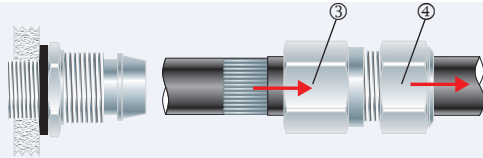

4. Pass the outer nut (4) and the body (3) over the cable.

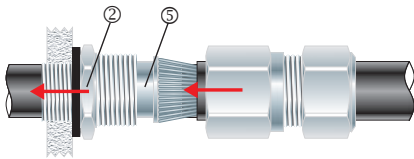

5. Pass the cable end through the inner (2). Splay the armour wires over the cone (5).

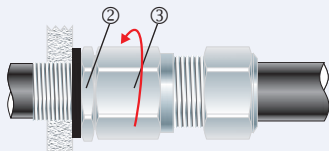

6. Tighten the body (3) onto the inner (2) until hand tight, then tighten with a CCG Spanner (7) with  $\frac{3}{4}$  turn to lock the armour between the cone (5) and the cone ring (6).

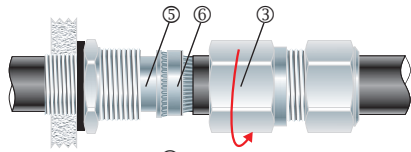

7. Unscrew the body (3). Check that the armour has locked between the cone (5) and cone ring (6) (O-Ring on the cone ring (6) is sacrificial).

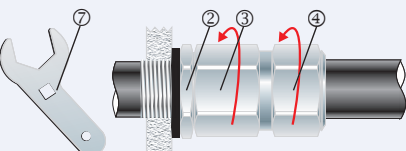

8. Tighten the body (3) onto the inner (2) to the installation torque using a CCG Spanner (7). Tighten the outer nut (4) to produce a moisture proof seal by turning until the seal makes contact with the outer sheath of cable and then make one full turn.

YouTube Instruction Video: <http://youtu.be/Lw-LxOyyoV0>

Alternative installation through an unthreaded entry.

If the apparatus is untapped use a locknut.

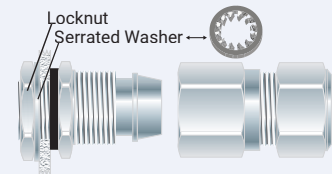

If the gland has NPT entry threads fitted to a threaded entry then IP68 (2m) can be achieved by applying one of the following tested and approved grease types to the thread:- Renolit Lubrene CA700 or LX220 EP2, Renolit LC-WP2 or Moly LX2, or Dow Corning 4 Electrical Compound.