

# 3-WAY BOTTOM ENTRY™

## JUNCTION BOX - Ex eb I, Ex eb IIC, Ex ec IIC, Ex tb IIC

### for Hazardous Area Installations



#### Features and Benefits

- 3-Way Bottom Entry™ Box for hazardous area lighting installations.
- For use in Group I mining (low impact areas), Group II and Group III applications.
- Screw-on lid provides ease of installation. Lid locking with a special key prevents unauthorized tampering.
- Supplied complete with safety securing lid lanyard.
- Only approved CCG cable glands and terminals must be used. No exposed metal parts.
- Dust and waterproof to IP66/68, when used with CCG sealed cable glands.
- No drilling or tapping of cable entries required. Mounting studs provided for DIN rail if using terminal blocks.
- Internal earthing to all entries and rail provided.

#### Technical Data

Type:	3-Way Bottom Entry™ Box
Box Material:	Impact corrosion and UV resistant glass reinforced polyester compound Polycarbonate (see-through adapt-a-lids) O ring seals: Silicone or Sarlink seals. Terminals: Wellamid or Wemidd
Inserts:	Brass internal earthing and rail mountings
Optional Accessories:	Certified Terminals, (see conditions on safe use-x) Blanking Plugs and Box Spanner (Lid Locking Key)
Note:	The installer should check that the materials are suitable for the installation environment.

#### Standards and Certifications

**Equipment Protection Levels:** SANS: (Finished) Ex e IIC T6 Gb / Ex nA IIC T6 Gc / Ex tb IIC T70°C Db  
 SANS: (Unfinished) Ex e IIC Gb / Ex nA IIC Gc / Ex tb IIC Db  
 IECEx/INMETRO: (Finished) Ex eb I Mb / Ex eb IIC T6 Gb / Ex ec IIC T6 Gc / Ex tb IIC T70°C Db / Ex tc IIC T70°C Dc  
 IECEx/INMETRO: (Unfinished) Ex eb I Mb / Ex eb IIC Gb / Ex ec IIC Gc / Ex tb IIC Db / Ex tc IIC Dc  
 ATEX/UKEX: (Finished) I M2, II 2GD / 3G Ex eb I Mb / Ex eb IIC T6 Gb / Ex ec IIC T6 Gc / Ex tb IIC T70°C Db / Ex tc IIC T70°C Dc  
 ATEX/UKEX: (Unfinished) I M2, II 2GD / 3G Ex eb I Mb / Ex eb IIC Gb / Ex ec IIC Gc / Ex tb IIC Db / Ex tc IIC Dc  
 CCC: (Finished) Ex eb IIC T6 Gb, Ex tb IIC T70°C Db, Ex tc IIC T70°C Dc  
 CCC: (Unfinished) Ex eb IIC Gb, Ex tb IIC Db, Ex tc IIC Dc

**Ambient Temperature:** -60°C to +55°C (Finished)

**Service Temperature:** -60°C to +110°C (Unfinished)

#### Conformance:

Standard:	Certificate:
IECEX	IEC 60079 Part 0, 7, 31, IEC 60529 IECEx MSC 20.0003X (Finished) IEC 60079 Part 0, 7, 31, IEC 60529 IECEx MSC 20.0004U (Unfinished)
ATEX	EN 60079 Part 0, 7, 31 CML 14ATEX3036X (Finished)
	EN 60079 Part 0, 7, 31 CML 14ATEX4038X (Finished)
	EN 60079 Part 0, 7, 31 CML 14ATEX3037U (Unfinished)
	EN 60079 Part 0, 7, 31 CML 14ATEX4039U (Unfinished)
UKEX	EN/BS 60079 Part 0, 7, 31 CML 21UKEX3008X (Finished)
	EN/BS 60079 Part 0, 7, 31 CML 21UKEX4010X (Finished)
	EN/BS 60079 Part 0, 7, 31 CML 21UKEX3007U (Unfinished)
	EN/BS 60079 Part 0, 7, 31 CML 21UKEX4009U (Unfinished)
INMETRO (Brazil)	ABNT NBR IEC 60079 Part 0, 7, 31, IEC 60529 TÜV 15.0481X (Finished)
	ABNT NBR IEC 60079 Part 0, 7, 31, IEC 60529 TÜV 15.0482U (Unfinished)
TR CU (Russia)	ГОСТ 31610-0, 15, EAЭC RU C-ZA.HA91.B.00243/21 (Finished/Unfinished)
	ГОСТ P MЭK 60079-7, 31
CCC/CNEx (Chinese)	GB/T3836.1, 3, 31-2021 CNEx 21.3507X (Finished)
	GB/T3836.1, 3, 31-2021 CCC 2021312303000506 (Finished)
	GB/T3836.1, 3, 31-2021 CNEx 21.3390X (Unfinished)
	GB/T3836.1, 3, 31-2021 CCC 2021312313000393 (Unfinished)
SANS	SANS/IEC 60079 Part 0, 7, 31 MASC S/21-9001X (Finished)
	SANS/IEC 60529 MASC S/21-9002U (Unfinished)
IP66/68 2m Protection	IEC 60529 IECEx CML 15.0071U
	Marine ABS IEC 60529 ABS 20-SG1952738-1-PDA
DNV ClassNK	IEC 60529 TAE0000011
	IEC 60079 Part 0, 7, 31 TA20268M
Deluge Protection	DTS-01 CML 14CA370-1
	Short Circuit/ Cont.Current IEC 60947-7-2, IEC 62444 CATAPULT OR/15/11677_2

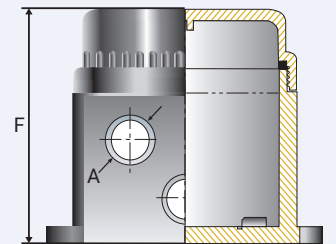
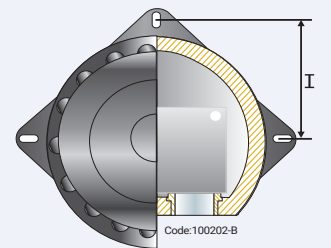
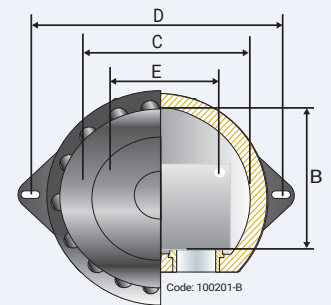

PATENTED



#### Conditions for Safe Use - X

- In Group I applications, the junction box must only be used in low impact areas and where it is not exposed to oils or greases.
- Only the CCG tool supplied shall be used for opening / closing the enclosure.
- Suitably certified cable glands and/or plugs shall be used in the enclosure threaded entries
- Terminal blocks shall only be used on the applicable rail and shall allow sufficient space to make connections and to close the cover / lid. Only the Weidmuller terminals shown in Table 2 may be used.
- The creepage and clearance between terminal blocks and from the terminal block to any earthed / bonded metallic part shall comply with the EN60079-7 requirements for the acceptable voltage of the terminal blocks.

Product Code	Box Size Reference	Entry Thread 'A'	Inside Dimension 'B'	Internal Diameter 'C'	Mounting Centres 'D'	Rail Mounting Centres 'E'	Outer Height 'F'	Dim. 'I'
100201-B	1	M20 x 1.5	68.0	101.0	132.0	80.0	124.0	-
100202-B	2	M25 x 1.5	100.0	123.0	162.0	92.0	160.0	81.0

All dimensions are in mm.

# 3-WAY BOTTOM ENTRY™ JUNCTION BOX

## Conditions for Safe Use - X

- The current in the junction box is limited by the size of the conductor and shall not exceed as per the table below.
- Only the terminals listed below may be used, following the specific installation conditions set down by the terminal manufacturer/terminal certification.

Manufacturer	Certificate No.	Ex Coding	Type	Conductor / Terminal Block Size	Maximum Current	
					≤ 55°C Ambient	≤ 40°C Ambient
Weidmuller	IEC Ex ULD14.0005U Demko 14ATEX1338U CCC 2021312303000506	Ex eb IIC	WDU 2.5, 4, 6, 10, 16, 35 and 70N WPE 2.5, 4, 6, 10, 16, 35 and 70N	2,5 mm <sup>2</sup>	8,34 A	11,90 A
				4 mm <sup>2</sup>	11,12 A	15,86 A
				6 mm <sup>2</sup>	14,25 A	20,33 A
				10 mm <sup>2</sup>	19,81 A	28,26 A
				16 mm <sup>2</sup>	26,42 A	37,68 A
				35 mm <sup>2</sup>	43,46 A	61,98 A
				50 mm <sup>2</sup>	52,50 A	74,88 A
Weidmuller	IECEx TUR18.0024U TÜV 18 ATEX 8221U CCC 2021312313000393	Ex eb IIC	AKZ4 and AKE4	4mm <sup>2</sup>	-	-
				75 mm <sup>2</sup>	66,75 A	95,21 A

## Wiring and Installation instructions for 3-Way Bottom Entry™ Box without components

- Installation must be carried out by a competent person.
- The box must not be modified in any way, as this will invalidate the certification.
- Where cables enter the box they must be secured by CCG Cable Glands appropriate to the make up of the cable.
- Unused entry apertures must be blanked with certified CCG Blanking Plugs.
- To maintain IP 66/68 a thread seal gasket between the box and cable gland must be installed.
- Before replacing the lid, ensure the lid gasket is in place.
- The use of a CCG Box Spanner (Lid Locking Key) is required to maintain the tamper proof integrity of the box, refer Figure 1.

## Wiring and Installation instructions for 3-Way Bottom Entry™ Box with components

- Installation must be carried out by a competent person.
- Do not install under live current conditions.
- The box must not be modified in any way, as this will invalidate the certification.
- All wiring must be carried out in accordance with the relevant Codes of Practice.
- The wiring insulation must not extend by more than 1.0mm from the metal face of the terminal as shown in Figure 2.
- The voltage and current value of the box must not be exceeded.  
See relevant certificate for current limitations for conditions of use / schedule of limitations.
- Only those terminals shown in the terminal schedule may be incorporated in the box, refer Table 1.
- Inner cable bedding must protrude into the box by a minimum of 20mm past the cable entry point.
- Not more than one single or multiple strand lead shall be connected into either side of the terminals.
- Only earth conductors of equal size shall be connected with rail mounted terminals.
- All terminal screws used and unused shall be tightened.
- A parallel shaft screw driver of the correct size should be used for rail mounted terminals screws.
- Where cables enter the box they must be secured by CCG Cable Glands appropriate to the make up of the cable.
- Unused entry apertures must be blanked with certified CCG Blanking Plugs.
- To maintain IP66/68 a thread seal gasket between the box and cable gland must be installed.
- Before replacing the lid, ensure the lid gasket is in place.
- The use of a CCG Box Spanner (Lid Locking Key) is required to maintain the tamper proof integrity of the box, refer Figure 1.

**FIGURE 1**

To ensure the box apparatus is tamper proof: Screw on, tighten and lock lid in place by means of a CCG Box Spanner (Lid Locking Key).

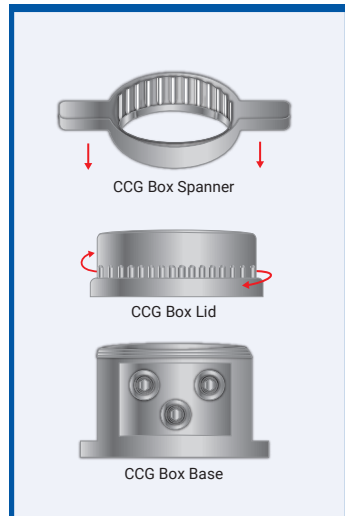

### CCG Box Spanner

Product Code	Box Size
401201	1
401202	2

**TABLE 1**

Box Type	Box Size	Terminal Type and Size	Max Quantity	Rail Size
3-Way BE Box	1	4mm <sup>2</sup> mini terminal	8	15
3-Way BE Box	2	2.5mm <sup>2</sup>	12	35
3-Way BE Box	2	4mm <sup>2</sup>	10	35
3-Way BE Box	2	4mm <sup>2</sup> mini terminal	12	15
3-Way BE Box	2	6mm <sup>2</sup>	8	35
3-Way BE Box	2	10mm <sup>2</sup>	7	35
3-Way BE Box	2	16 mm <sup>2</sup>	6	35
3-Way BE Box	2	35mm <sup>2</sup>	3	35

**TABLE 2**

VOLTAGE PER TERMINAL CONFIGURATION		
Terminals	Volt	Earth Terminals
AKZ 4	275V	AKE 4
WDU 2.5	550V	WPE 2.5
WDU 4	550V	WPE 4
WDU 6	550V	WPE 6
WDU 10	550V	WPE 10
WDU 16	550V	WPE 16
WDU 35	550V	WPE 35

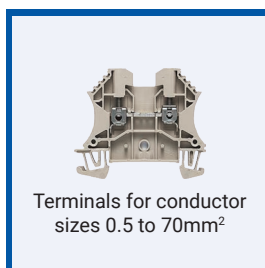
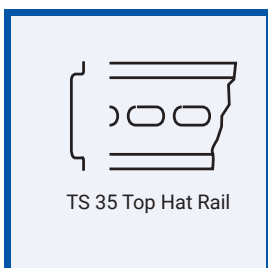
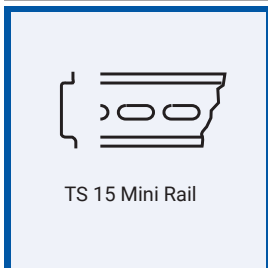

**FIGURE 2**

The wiring insulation must not extend by more than 1.0mm from the metal face of the terminal as shown below.

